

PRODUCT DATA SHEET

1 POLE DISTRIBUTION BLOCKS



DESCRIPTION

Distribution Blocks are used in electricity distribution. An electrical distribution terminal block is a convenient, economical and safe way to distribute power from a single input source to multiple outputs. Complete with main removable cover. High conductivity with excellent electrical contacts

FEATURES

- Compact design.
- Hinged design with safety removable cover.
- Dustproof and insulation cover.
- Mounting on 35mm wide DIN rail with screws.
- Material: Plastic, Copper

MARKINGS



- According to CE

PRODUCT DATA SHEET

1 POLE DISTRIBUTION BLOCKS

SECTIONS AND DIMENSIONS

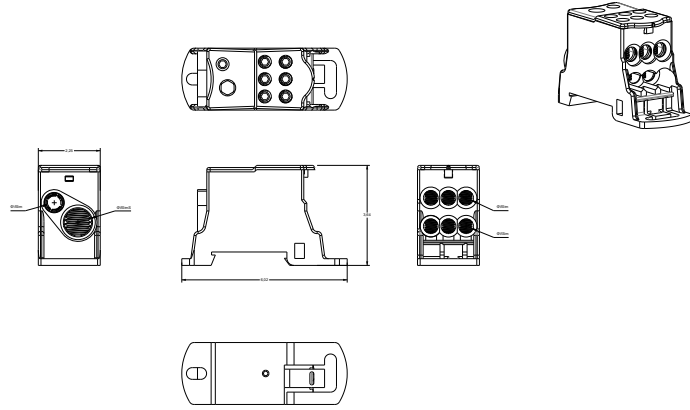

PRODUCT CODE	GW - 160A	
CURRENT	160 Ampere	
CABLE TYPE	SINGLE CORE	MULTI CORE
CABLE SECTION (mm ²)	Input	Output
	1x10-70 mm ²	6x2,5-16 mm ² Diplexer 1x6-16 mm ²